

100 Series CLAMPS & GRIPPERS CATALOG

Standard 25mm bore **light duty** clamps, grippers, and pin clamps



360° manually rotatable head for MOST models

Common mounting pattern for all models

Designed for high production



Part of BTM's Products for Automation
<http://www.btmcomp.com/products.html>



BTM[®]
COMPANY

www.btmcomp.com

810-364-4567

**SAFETY NOTE**

It is the customer and/or user's responsibility to provide proper safety controls and/or guarding when a pinch point is present.

FEATURES

- Compact, light weight, light-duty clamps & grippers.
- Designed for high-production.
- 25mm bore pneumatic cylinders
- Common mounting pattern for all models
- Position-sensing switch option available

MANUALLY POSITIONABLE HEAD

Except for the Rotary-Linear Clamp, and the Pin Clamp, BTM's 100 series clamps & grippers are OMNI style and feature a manually positionable 360° rotating head.

Simplify off-center mounting by rotating the head to the desired position and mounting the body squarely.

The head is locked into place when the mounting screws are tightened.

REDUCE COST

Reduce your fixturing costs by eliminating angled mounting surfaces.

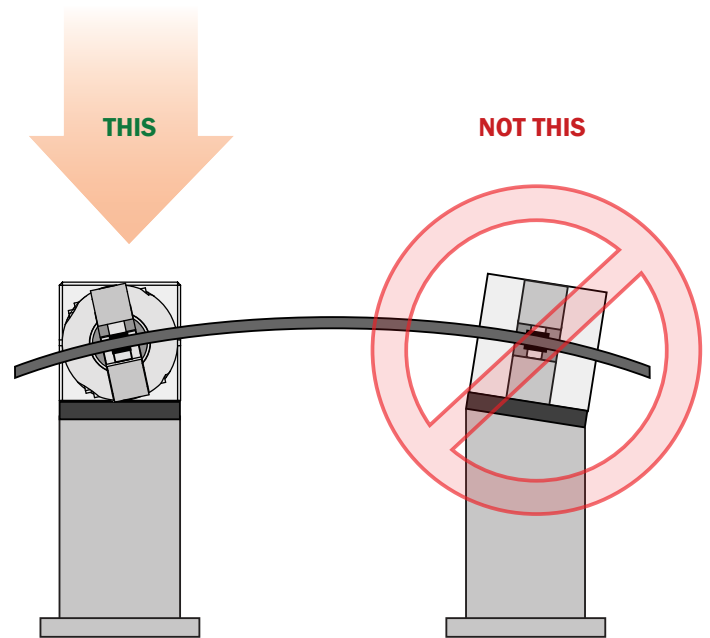
**BTM'S STANDARD 100 SERIES CLAMP & GRIPPER LINE**

! BTM reserves the right to make changes to its literature without any prior notice. Go to www.btmcomp.com for latest version.

TABLE OF CONTENTS

GRIPPERS

20° SINGLE OPENING GRIPPER 4

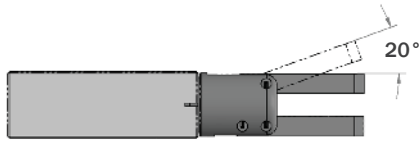

40° DOUBLE OPENING GRIPPER 5

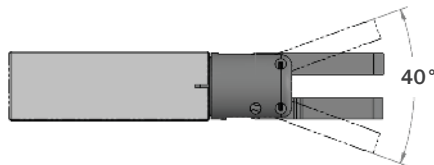

180° GRIPPER 6

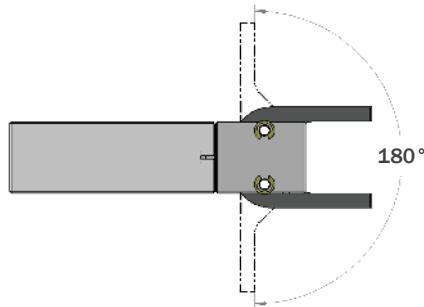

PARALLEL GRIPPER 7

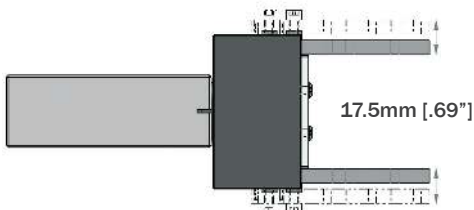

CLAMPS

VERTICAL CLAMP 8

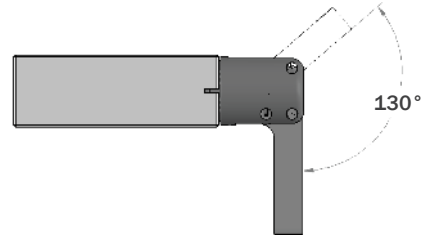

HORIZONTAL CLAMP 9

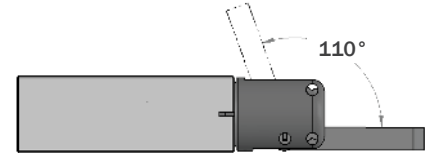

LINEAR CLAMP 10

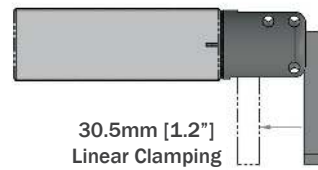

ROTARY-LINEAR CLAMP 11

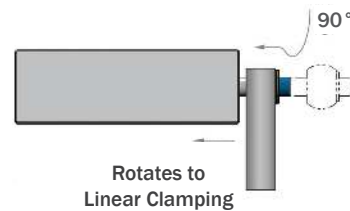

PIN CLAMP

PLC25 12-13

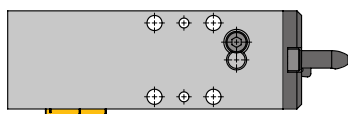

SWITCH INFORMATION 14

WARRANTY INFORMATION 15

20° SINGLE OPENING GRIPPER

Bore Ø	25.4 [1.00in]
Stroke	6.6 [0.26in]
Total Arm Opening	20°
Recommended Operating Pressure	4.0 - 6.9 BAR [60 - 100 PSI]
Approximate Weight	0.34 kg [.75 lbs]

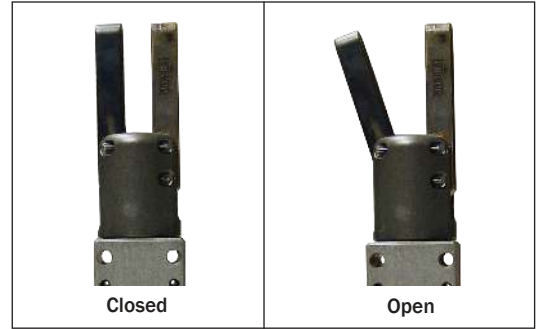

- Use Flow Control to Reduce Impact -

Clamping Force	
NEWTONS	821.6 x Line Pressure (BAR)
	Length (mm) from POINT "A" to the center line of gripping contact area on gripper arm
POUNDS	.50 x Line Pressure (PSI)
	Length (in) from POINT "A" to the center line of gripping contact area on gripper arm

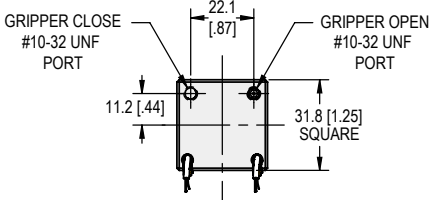
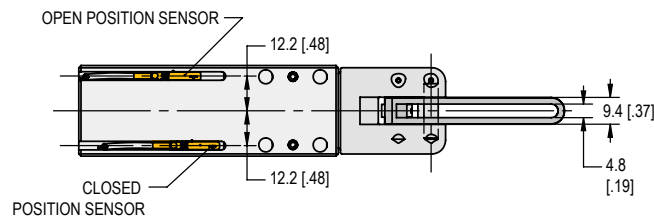
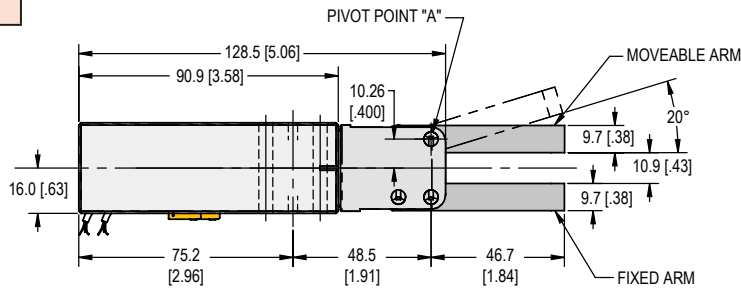
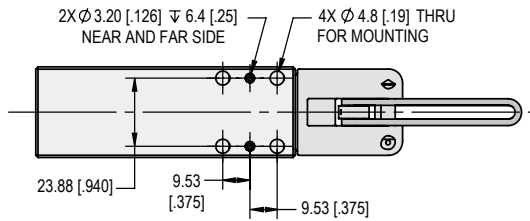

HOW TO ORDER

GRIPPER SELECTION	SERIES	ARM OPENING	SENSING
PGO	100	S20	MPEDC
Power Gripper OMNI	100 Series	S20 = Single 20° Opening	<p>Sensing Option (See p.14 for more info.)</p> <p>MPEDC = Efector DC Magnetic Position Sensing Switch (Note: 2 switches included & required)</p> <p>MPBDC = Balluff DC Magnetic Position Sensing Switch (Note: 2 switches included & required)</p> <p>NS = No Switch</p>

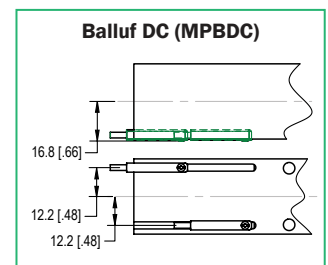
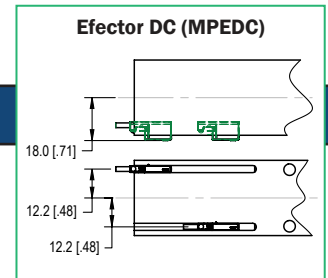

40° DOUBLE OPENING GRIPPER

Bore Ø	25.4 [1.00in]
Stroke	6.6 [0.26in]
Total Arm Opening	40°
Recommended Operating Pressure	4.0 - 6.9 BAR [60 - 100 PSI]
Approximate Weight	0.34 kg [0.75 lbs]

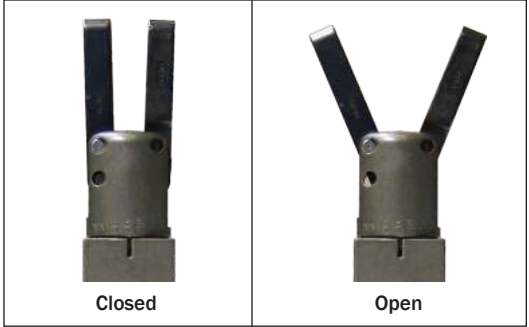

-- Use Flow Control to Reduce Impact --

Clamping Force	
NEWTONS	821.6 x Line Pressure (BAR)
	Length (mm) from POINT "A" to the center line of gripping contact area on gripper arm
POUNDS	.50 x Line Pressure (PSI)
	Length (in) from POINT "A" to the center line of gripping contact area on gripper arm

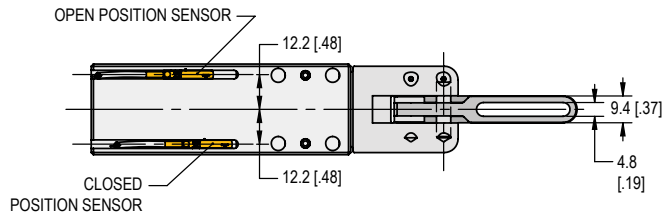
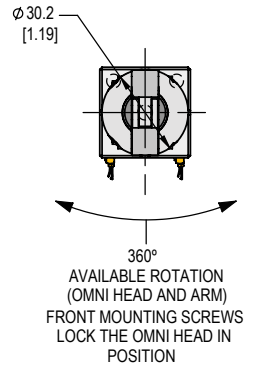
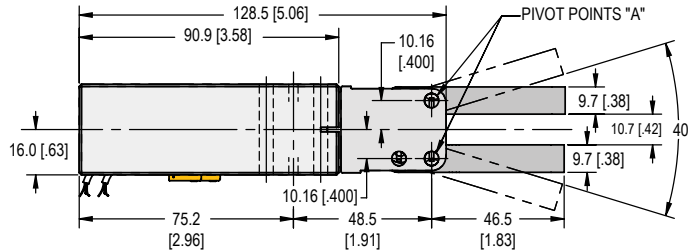
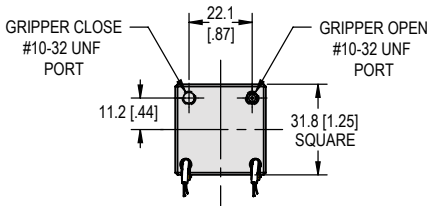
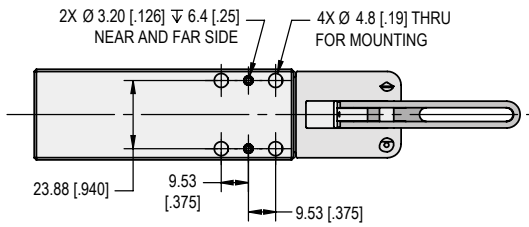

HOW TO ORDER

GRIPPER SELECTION	SERIES	ARM OPENING	SENSING
PGO	100	D40	MPEDC
Power Gripper OMNI	100 Series	D40 = Double 40° Opening	<p>Sensing Option (See p.14 for more info.)</p> <p>MPEDC = Efector DC Magnetic Position Sensing Switch (Note: 2 switches included & required)</p> <p>MPBDC = Balluff DC Magnetic Position Sensing Switch (Note: 2 switches included & required)</p> <p>NS = No Switch</p>

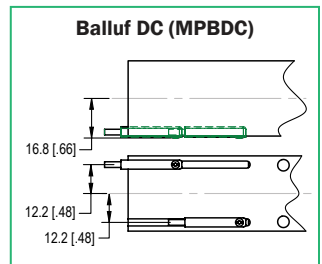
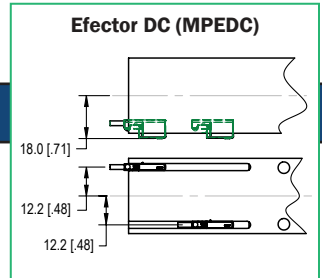

180° GRIPPER

Bore Ø	25.4 [1.00in]
Stroke	24.1 [0.95in]
Total Arm Opening	180°
Recommended Operating Pressure	4.0 - 6.9 BAR [60 - 100 PSI]
Approximate Weight	0.54 kg [1.2 lbs]

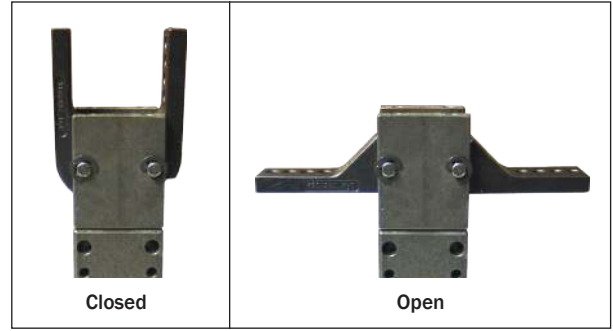

- Use Flow Control to Reduce Impact -

Clamping Force	
NEWTONS	821.6 x Line Pressure (BAR)
	Length (mm) from POINT "A" to the center line of gripping contact area on gripper arm
POUNDS	.50 x Line Pressure (PSI)
	Length (in) from POINT "A" to the center line of gripping contact area on gripper arm

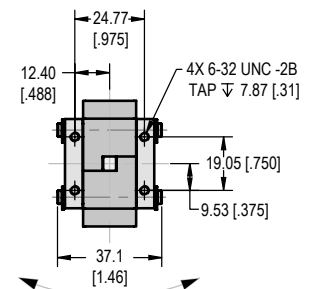
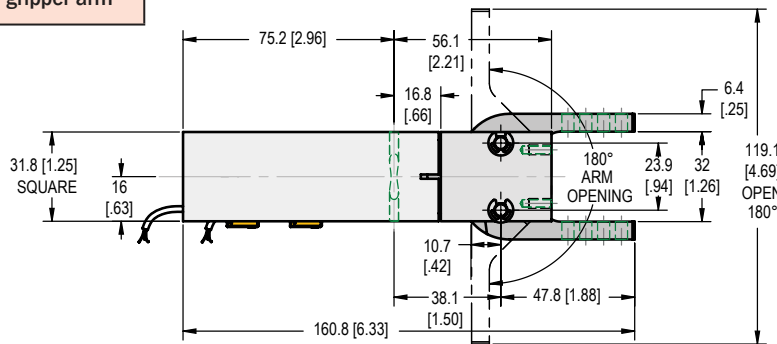
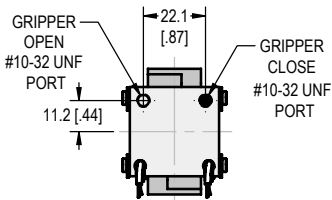
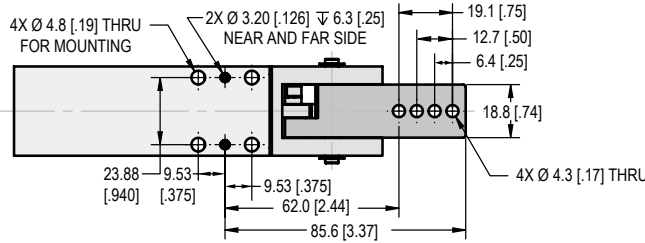

360° AVAILABLE ROTATION (OMNI HEAD AND ARM)
FRONT MOUNTING SCREWS LOCK THE OMNI HEAD IN POSITION

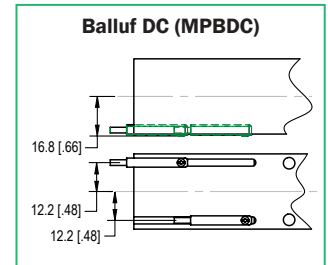
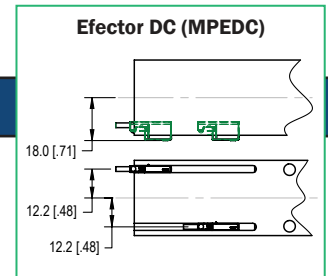
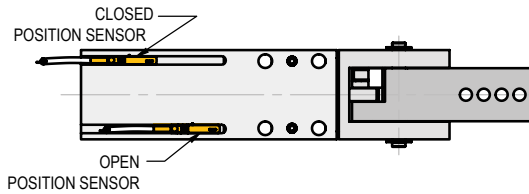

HOW TO ORDER

GRIPPER SELECTION	SERIES	ARM OPENING	SENSING
PGO	100	D180	MPEDC
Power Gripper OMNI	100 Series	D180 = Double 180° Opening	Sensing Option (See p.14 for more info.)
			MPEDC = Efector DC Magnetic Position Sensing Switch (Note: 2 switches included & required)
			MPBDC = Balluff DC Magnetic Position Sensing Switch (Note: 2 switches included & required)
			NS = No Switch

PARALLEL GRIPPER

Bore Ø	25.4 [1.00in]
Stroke	21.8 [0.86in]
Total Arm Opening	17.5 [0.69in]
Recommended Operating Pressure	4.0 - 6.9 BAR [60 - 100 PSI]
Approximate Weight	0.64 kg [1.4 lbs]

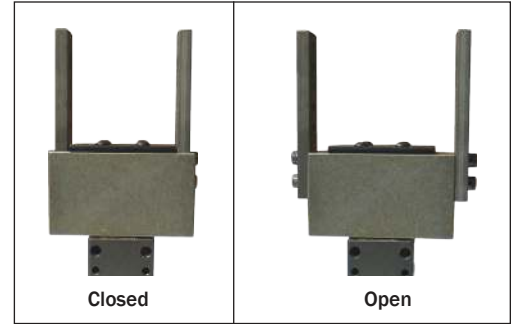

-- Use Flow Control to Reduce Impact --

Clamping Force	
NEWTONS	20 x Line Pressure (BAR)
POUNDS	.31 x Line Pressure (PSI)

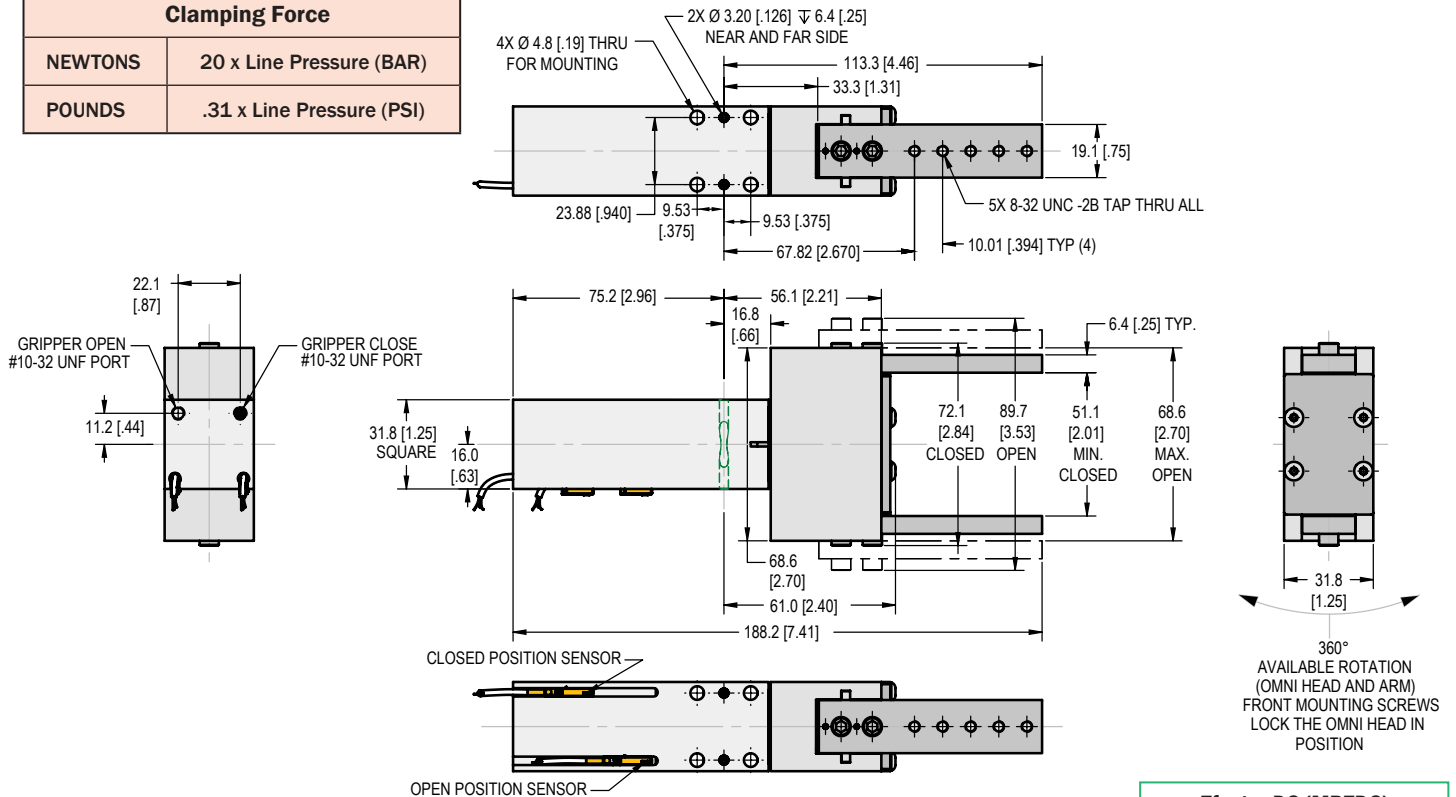

HOW TO ORDER

GRIPPER SELECTION	SERIES	ARM OPENING	SENSING
OPG	100	17.5mm	MPEDC
OMNI Parallel Gripper	100 Series	17.5mm = Total Arm Opening	<p>Sensing Option (See p.14 for more info.)</p> <p>MPEDC = Efactor DC Magnetic Position Sensing Switch (Note: 2 switches included & required)</p> <p>MPBDC = Balluff DC Magnetic Position Sensing Switch (Note: 2 switches included & required)</p> <p>NS = No Switch</p>

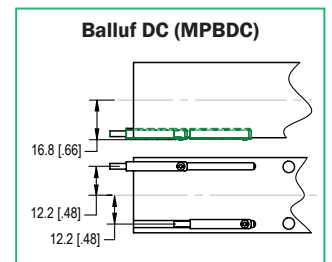
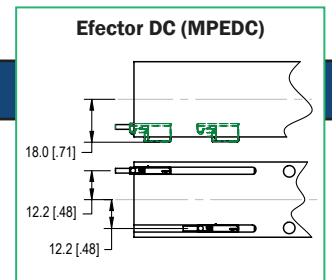

130° VERTICAL CLAMP

Bore Ø	25.4 [1.00in]
Stroke	29.2 [1.15in]
Total Arm Opening	130°
Recommended Operating Pressure	4.0 - 6.9 BAR [60 - 100 PSI]
Approximate Weight	0.34 kg [0.75 lbs]

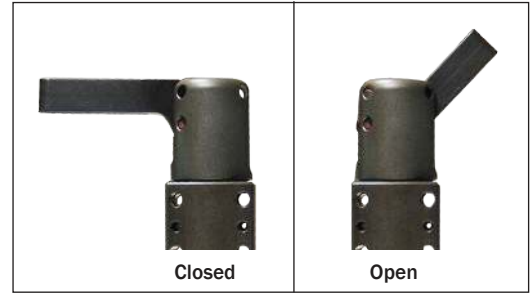

-- Use Flow Control to Reduce Impact --

Clamping Force	
NEWTONS	821.6 x Line Pressure (BAR)
	Length (mm) from POINT "A" to the center line of gripping contact area on gripper arm
POUNDS	0.50 x Line Pressure (PSI)
	Length (in) from POINT "A" to the center line of gripping contact area on gripper arm

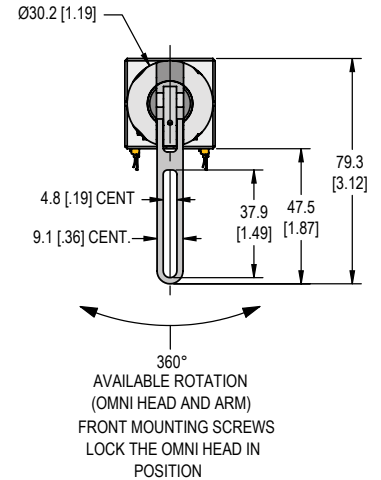
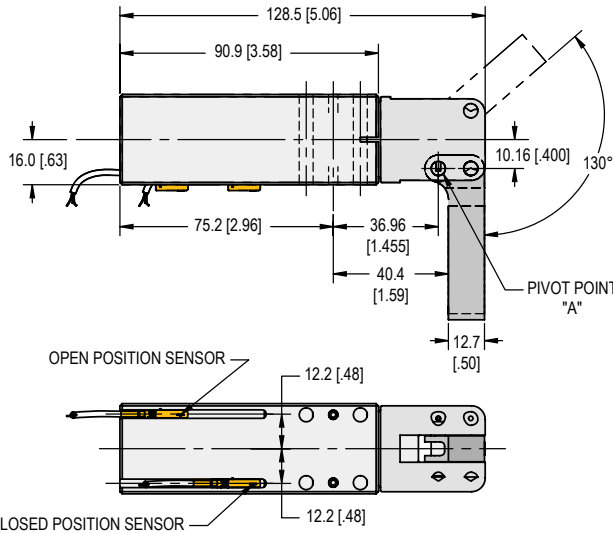
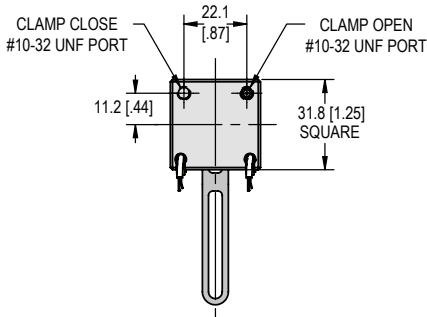
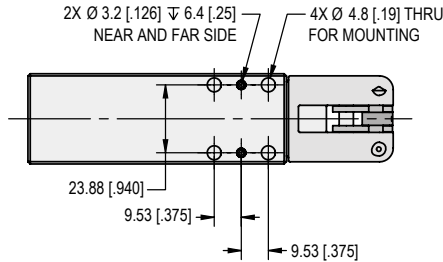

HOW TO ORDER

GRIPPER SELECTION	SERIES	ARM OPENING	SENSING
PCO Power Clamp OMNI	100 100 Series	V130 V130 = Vertical 130° Opening	MPEDC Sensing Option (See p.14 for more info.) MPEDC = Efactor DC Magnetic Position Sensing Switch (Note: 2 switches included & required) MPBDC = Balluff DC Magnetic Position Sensing Switch (Note: 2 switches included & required) NS = No Switch

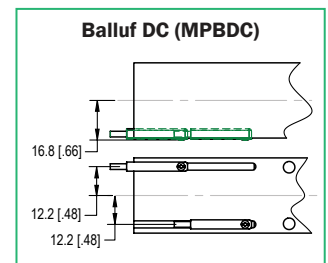
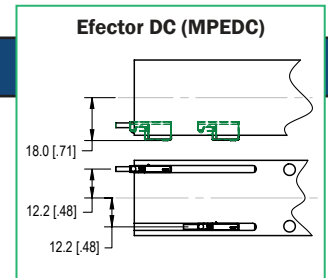

110° HORIZONTAL CLAMP

Bore Ø	25.4 [1.00in]
Stroke	25.9 [1.02in]
Total Arm Opening	180°
Recommended Operating Pressure	4.0 - 6.9 BAR [60 - 100 PSI]
Approximate Weight	0.30 kg [0.671 lbs]

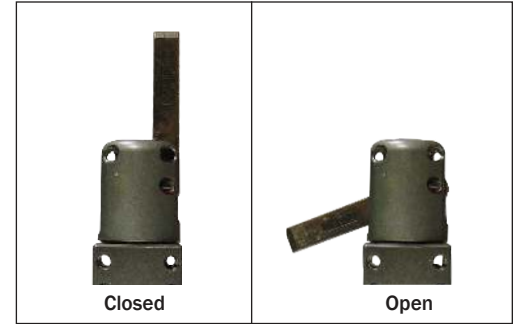

-- Use Flow Control to Reduce Impact --

Clamping Force	
NEWTONS	821.6 x Line Pressure (BAR)
	Length (mm) from POINT "A" to the center line of gripping contact area on gripper arm
POUNDS	0.50 x Line Pressure (PSI)
	Length (in) from POINT "A" to the center line of gripping contact area on gripper arm

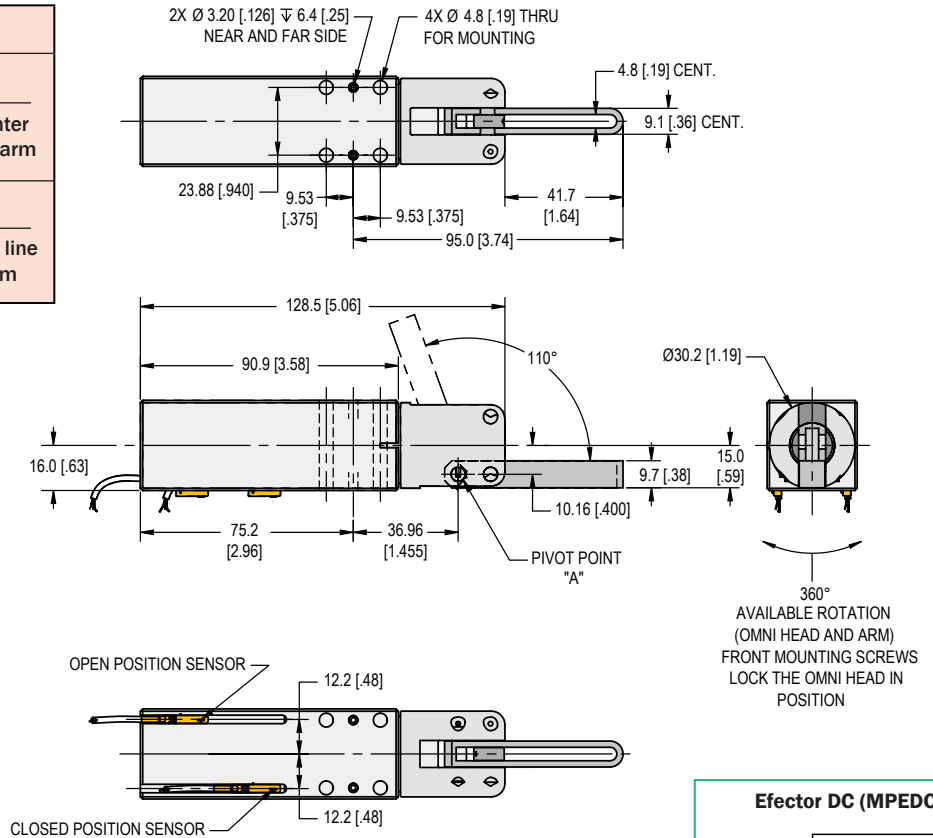
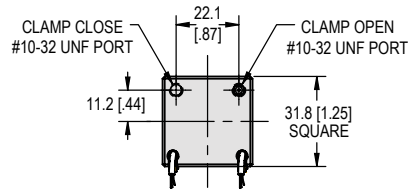

HOW TO ORDER

GRIPPER SELECTION	SERIES	ARM OPENING	SENSING
PCO	100	H110	MPEDC
Power Clamp OMNI	100 Series	H110 = Horizontal 110° Opening	Sensing Option (See p.14 for more info.) MPEDC = Efector DC Magnetic Position Sensing Switch (Note: 2 switches included & required) MPBDC = Balluff DC Magnetic Position Sensing Switch (Note: 2 switches included & required) NS = No Switch

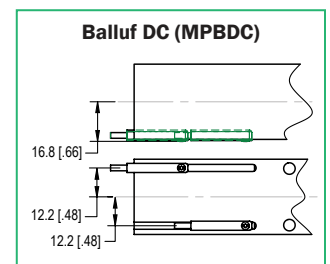
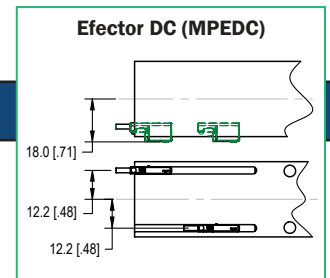

LINEAR CLAMP

Bore Ø	25.4 [1.00in]
Stroke	29.2 [1.15in]
Total Arm Opening	29.2 [1.15in]
Recommended Operating Pressure	4.0 - 6.9 BAR [60 - 100 PSI]
Approximate Weight	0.30 kg [0.659 lbs]

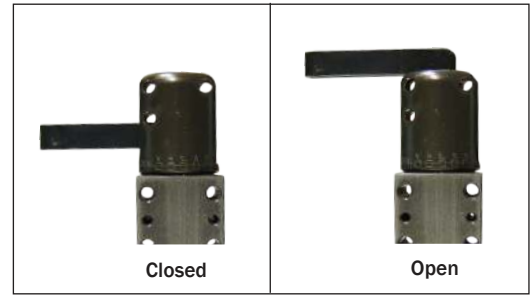

-- Use Flow Control to Reduce Impact --

Clamping Force	
NEWTONS	42 x Line Pressure (BAR)
POUNDS	0.65 x Line Pressure (PSI)

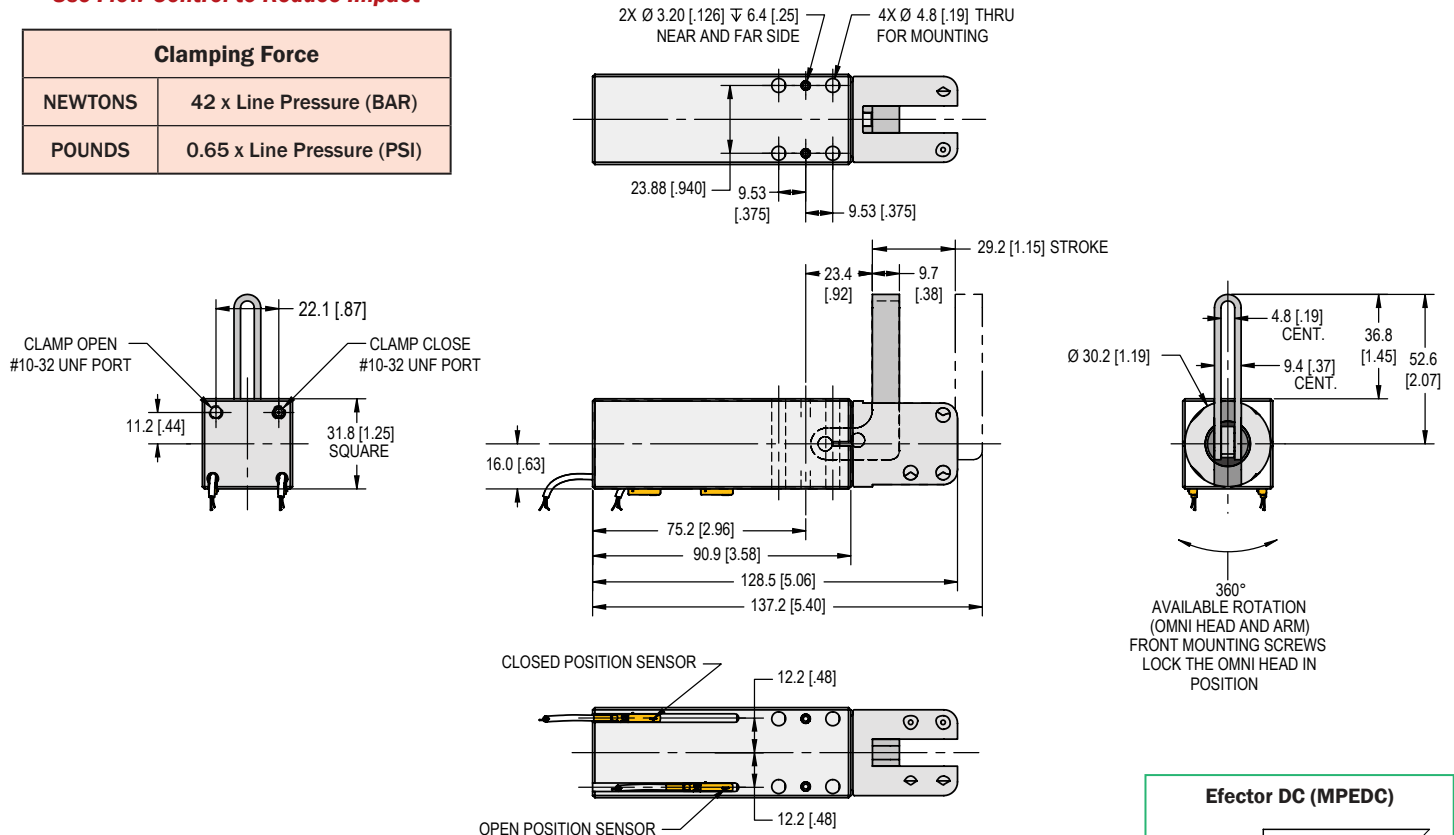

HOW TO ORDER

GRIPPER SELECTION	SERIES	ARM OPENING	SENSING
PCO	100	SL1.2	MPEDC
Power Clamp OMNI	100 Series	SL1.2 = 29.2 [1.15in] Linear Arm Opening	Sensing Option (See p.14 for more info.) MPEDC = Efector DC Magnetic Position Sensing Switch (Note: 2 switches included & required) MPBDC = Balluf DC Magnetic Position Sensing Switch (Note: 2 switches included & required) NS = No Switch

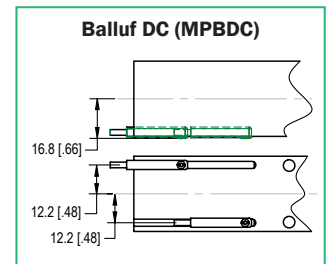
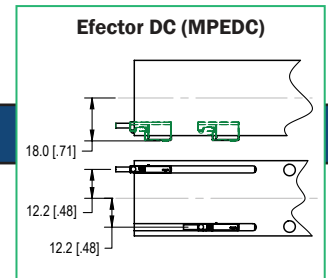

ROTARY-LINEAR CLAMP

Bore Ø	25.4 [1.00in]
Stroke	25.9 [1.02in]
Total Arm Opening	25.91 [1.02in] Total Stroke Consists of: • 7.87 [0.31in] - 90° rotation • 18.03 [0.71in] linear travel
Recommended Operating Pressure	4.0 - 6.9 BAR [60 - 100 PSI]
Approximate Weight	0.35 kg [0.769 lbs]

-- Use Flow Control to Reduce Impact --

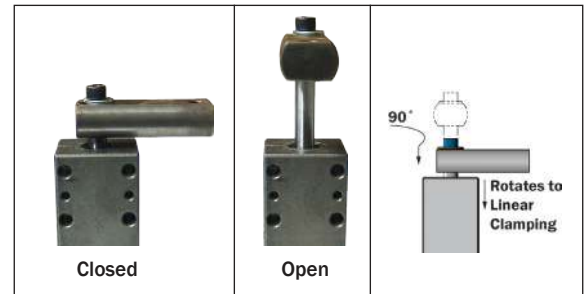

Clamping Force	
NEWTONS	42 x Line Pressure (BAR)
POUNDS	0.65 x Line Pressure (PSI)

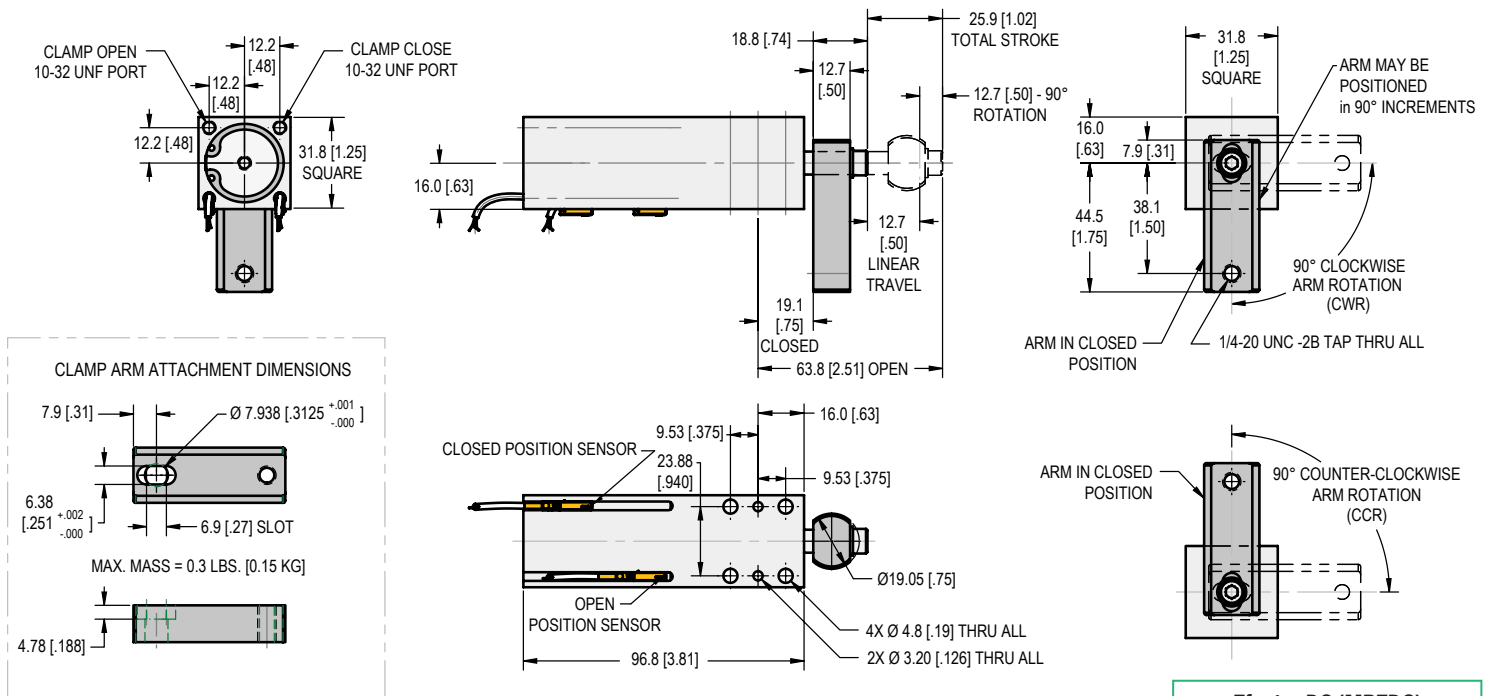

HOW TO ORDER

GRIPPER SELECTION

RCO

Rotary Clamp OMNI

SERIES

100

100 Series

ARM ROTATION

90 - **CWR**

Arm Rotation

90 = 90 Degrees

Rotation Direction

CWR = Clockwise

CCR = Counter-Clockwise

SENSING

MPEDC

Sensing Option (See p.14 for more info.)

MPEDC = Efector DC Magnetic Position Sensing Switch (Note: 2 switches included & required)

MPBDC = Balluff DC Magnetic Position Sensing Switch (Note: 2 switches included & required)

NS = No Switch

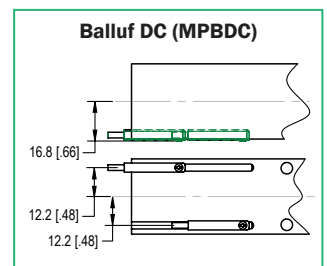
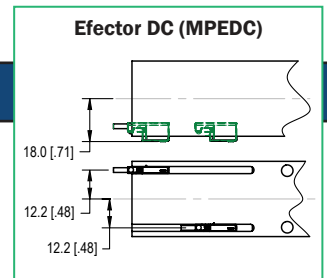

PLC25 LIGHT DUTY PIN CLAMPS

A non-locking light duty pin locator clamp designed to clamp through small holes or slots.

Hole/Slot Size	6mm - 12mm
Clamping Force	222N @ 5.5BAR (50lbf @ 80PSI)
Finger Travel	6mm [0.24"] Total Consists of: <ul style="list-style-type: none"> • 3mm [0.12in] rotational • 3mm [0.12in] straight line pull down stroke
Bore Diameter	25.4mm [1.00in]
Cylinder Stroke	7.0mm [0.28in]
Recommended Operating Pressure	4.0 - 6.9 BAR [60 - 100 PSI]
Approximate Weight	.28 kg [.62 lbs] (depending on pin size)



- Use Flow Control to Reduce Impact -

HOW TO ORDER

CLAMP SELECTION	PIN SELECTION	SENSING	ASSEMBLY NUMBER																		
PLC25	6.00	MPEDC	PD226300A																		
Clamp Series	Pin Diameter	Sensing Option (See p.14 for more info.)	Include Standard BTM Number OR Special Number																		
	<table border="1"> <tr><td>6.00</td></tr> <tr><td>8.00</td></tr> <tr><td>10.00</td></tr> <tr><td>12.00</td></tr> <tr><td>See p. 13</td></tr> </table>	6.00	8.00	10.00	12.00	See p. 13	<table border="1"> <tr><td>MPEDC = Effector DC Magnetic Position Sensing Switch (Note: 2 switches included & required)</td></tr> <tr><td>MPBDC = Balluff DC Magnetic Position Sensing Switch (Note: 2 switches included & required)</td></tr> <tr><td>NS = No Switch</td></tr> </table>	MPEDC = Effector DC Magnetic Position Sensing Switch (Note: 2 switches included & required)	MPBDC = Balluff DC Magnetic Position Sensing Switch (Note: 2 switches included & required)	NS = No Switch	<table border="1"> <thead> <tr> <th>Pin Dia. (h6)</th> <th>BTM Number</th> </tr> </thead> <tbody> <tr><td>6.00</td><td>PD226300A</td></tr> <tr><td>8.00</td><td>PD226500A</td></tr> <tr><td>10.00</td><td>PD226700A</td></tr> <tr><td>12.00</td><td>PD226900A</td></tr> </tbody> </table>	Pin Dia. (h6)	BTM Number	6.00	PD226300A	8.00	PD226500A	10.00	PD226700A	12.00	PD226900A
6.00																					
8.00																					
10.00																					
12.00																					
See p. 13																					
MPEDC = Effector DC Magnetic Position Sensing Switch (Note: 2 switches included & required)																					
MPBDC = Balluff DC Magnetic Position Sensing Switch (Note: 2 switches included & required)																					
NS = No Switch																					
Pin Dia. (h6)	BTM Number																				
6.00	PD226300A																				
8.00	PD226500A																				
10.00	PD226700A																				
12.00	PD226900A																				

MPEDC - EFECTOR DC
BTM NO. 041424

Electrical Type	DC
Operating Voltage	10 - 30 V
Turn On Time	< 30 ms
Voltage Drop	< 2.5 V
Housing Material	PA

MPBDC - BALLUFF DC
BTM NO. 043828

Electrical Type	DC
Operating Voltage	10 - 30 V
Turn On Time	0.07 ms
Voltage Drop	3.1 V
Housing Material	PBT

PLC25 LIGHT DUTY PIN CLAMP

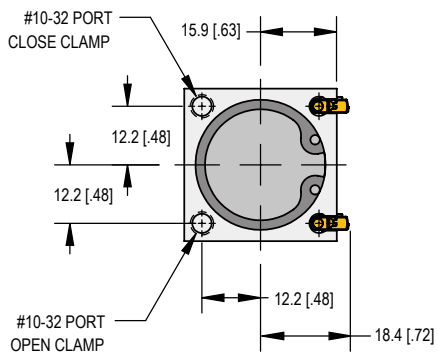
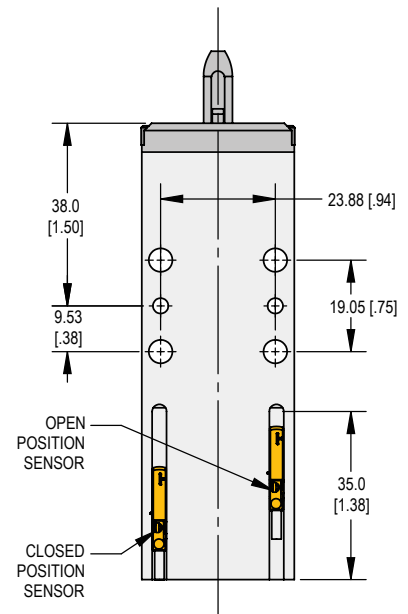
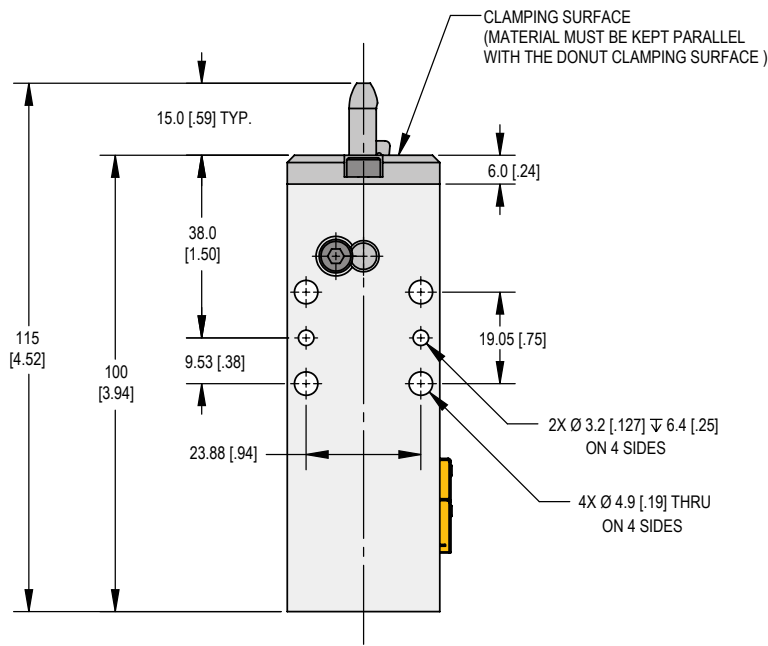
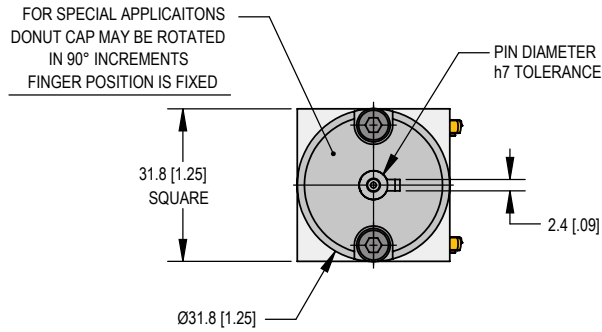

Pin Diameters

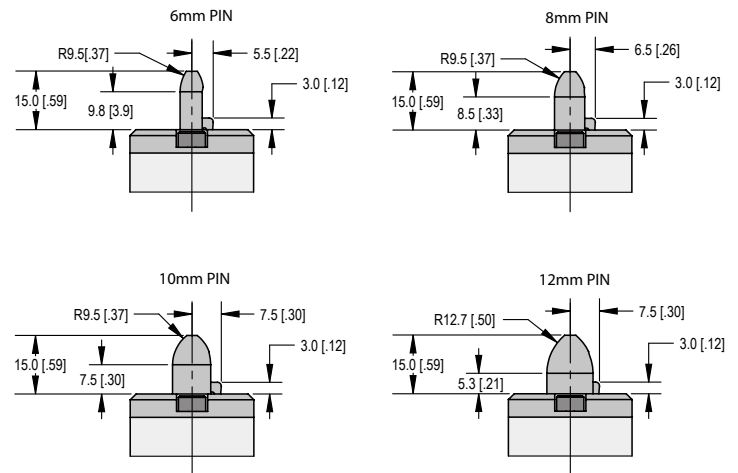

NOTE: BTM Pin Clamps can be ordered with custom designed (non-standard) pins, donuts, and/or fingers. In such instances, a SPECIAL OPTION number will be issued by BTM's Product Engineering Department. This number must be referenced when ordering a non-standard pin clamp.

SWITCH INFORMATION

Balluf or **Efactor** DC with:

- Magnetic Sensing
- Adjustable sensing location

(other switches may be available upon request)

Balluf DC

Function Indication
 Short circuit protected
 IP67 protection degree
 Polarity reversal resistant



Electrical Type	DC
Operating Voltage	10 - 30 V
Turn On Time	0.07 ms
Voltage Drop	3.1 V
Housing Material	PBT

WIRING:

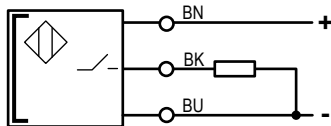

Balluf DC
BTM Number

043828

Efactor DC

Function Indication
 Short circuit protected
 IP67 protection degree
 Polarity reversal resistant

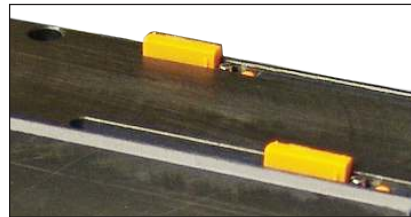

Electrical Type	DC
Operating Voltage	10 - 30 V
Turn On Time	< 30 ms
Voltage Drop	< 2.5 V
Housing Material	PA

WIRING:

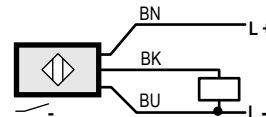

Efactor DC
BTM Number

041424

WARRANTY INFORMATION

BTM Company, LLC. warrants its 100 Series Clamps & Grippers against defects in material and workmanship for one (1) million cycles or a period of three (3) years after the ship date from BTM, which ever comes first.

This warranty is limited to replacing or repairing at BTM's option, F.O.B. BTM's factory, any part found by BTM to be defective in materials and/or workmanship. Any application of a BTM product outside the intended use of the product shall not be warranted by BTM Company, LLC. Furthermore, BTM will not be liable for any expenses incurred for repairs or replacement made outside BTM's facilities without written consent (or damages arising out of such replacements or repairs). Under no circumstances will BTM be held responsible for any consequential damages.

The warranty is limited to the repair or replacement of the defective part(s) and does not include installation.

This warranty is the only warranty extended by the seller in connection with any sale made hereunder and is in lieu of all other warranties, express, implied or statutory including warranties of merchantability and fitness for purpose.

BTM has a range of products for automation including:

Clamps



From heavy duty precision sealed locking power clamps to simple light duty OMNI models, BTM manufactures clamps in a range of styles and sizes for a wide variety of applications.

Grippers



BTM manufactures a high quality line of grippers ranging from heavy duty models to light duty models in a variety of styles and sizes.

Locator Clamps

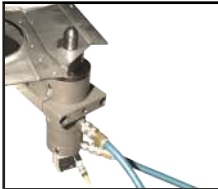

BTM's Locator Clamps are ideal for locating & holding production material and are used in a variety of manufacturing areas including automotive & refrigeration. Locking and Non-Locking Pin and Finger models available.

Precision Shot Pin Cylinders

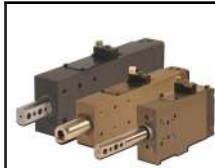

BTM's Precision Shot Pin Cylinders are ideal for locating production material through precisely pierced holes - including clamping and fixturing.

Air Toggle Presses



BTM's THIN Air Toggle Presses can be configured for a range of applications including Tog-L-Loc[®] clinching, piercing, riveting, and bending. Thin profile allows for close stacking. Available in a range of sizes and styles.

Air/Oil Cylinders



BTM Air/Oil Cylinders generate high forces with shop air pressure to perform various press operations. They can be used with many types of tooling, including Tog-L-Loc[®], Piercing, Riveting, Crimping, Stud insertion and Bending.

Specialized Units



BTM provides pneumatic, hydraulic, air/oil, and electrically driven units with single or dual motions for both stationary and robotic applications.



For more information, or to view our other products, please visit:

www.BTMCOMP.COM